



IT ALL STARTS  
WITH A VISION

# CONTENT

2

<b>GLASS RAILING SYSTEMS</b>	
Easy Glass® Hybrid	08
Easy Glass® Slim	12
Easy Glass® Max	16
<b>BALUSTER RAILING SYSTEMS</b>	
Q-line	22
Square Line®	26
<b>HANDRAIL SYSTEMS</b>	
Q-handrail	32

# THE NEW STANDARD IN DESIGNER RAILINGS

THE ULTIMATE IN RAILING SYSTEMS:  
INGENIOUS DESIGN, IMPECCABLE QUALITY,  
UNCOMPROMISING SAFETY

Q-railing is an innovator in the field of railing systems. We provide complete solutions that are instantly recognizable for their high quality, unique design and unparalleled performance. Around the world our professionals share an unsurpassed passion for innovation and a desire to spread the spirit of design excellence.

A Q-railing system will not only add prestige to your architectural design but will also provide the ultimate finishing touch that is characteristic of our reputation and vision. Enjoy having full

creative freedom to create a customized look using a wide selection of materials and components that allow your railing to blend into its surrounding architecture or to become a railing that makes a design statement in itself. Take advantage of our fully modular approach and extensive range of the best pre-engineered, pre-finished components, available in the market today. Each product line works in combination with many of the others, designed for time- and cost-saving installation.





# THE PREMIUM BRAND IN RAILING SYSTEMS

Q-RAILING'S REPUTATION FOR DESIGN EXCELLENCE EXTENDS GLOBALLY WITH AN EXTENSIVE LIST OF SUCCESSFULLY COMPLETED PROJECTS

Whether it is a custom home or a high-rise corporate project, a concert hall or stadium, an educational or commercial institution, Q-railing rises to levels of competence and service that are unrivalled in the industry.

## **Glass railing systems**

Transform the mundane into magnificent with our dry-glaze structural glass railing systems. Q-railing's high-grade designer lines create a sleek and sophisticated look while still conforming to building codes. The extruded aluminum base shoe is the contemporary alternative to conventional railing.

## **Baluster railing systems**

Explore the possibilities of our baluster railings that combine modern aesthetics with modular interchangeability. Give a stairway, balcony or atrium

a distinguished look with a Q-railing baluster railing system. Designs based on round, square or rectangular forms are available, along with a choice of cables, bars, web or glass for the infills.

## **Handrail systems**

A great-looking handrail can be the detail that transforms a space. Different materials create different atmospheres which is why Q-railing offers a broad range of handrails in stainless steel and various types of wood. Regardless of the type of wall or glass the system will be installed on, or the look you wish to achieve, Q-railing has a bracket that will deliver.



# GLASS RAILING SYSTEMS

8

# EASY GLASS® HYBRID

THE BEST OF TWO WORLDS

THIS HIGHLY AFFORDABLE RANGE FUNCTIONS BOTH AS A WALL-MOUNTED GLASS BALUSTRADE SOLUTION AND AS A BALUSTER-SUPPORTED GLASS RAILING.



## NEARLY INVISIBLE

Easy Glass® Hybrid's strength comes from the precise design of its cap rails and thin aluminum base shoes, which are just 1-3/4" (43mm) high. In addition, the system can be reinforced with extra-strong yet visually thin posts that are only 1/2" (12mm) wide.







## PROJECTS

Easy Glass Hybrid is an ideal solution for projects that require a value engineered glass balustrade combined with virtually unnoticeable structural support. Balconies and roof terraces are easily transformed into modern-looking elements of design.



## STRIKING CONTRASTS

EASY GLASS HYBRID IS ONE OF Q-RAILING'S LIGHTEST AND MOST ECONOMICAL GLASS RAILING SYSTEMS. IT IS DESIGNED FOR EASE OF INSTALLATION AND LOW MAINTENANCE.

You can use Easy Glass Hybrid as a full glass balustrade mounted between two walls. With the larger of the two cap rails you can create an approved baluster-free railing up to 4 feet (1.5m) wide. Should your project call for a longer balustrade, simply add the slender baluster posts. The system's modular structure allows for flexibility in terms of the number of balusters required.

The steel balusters are available in four different sizes, two for top mounting and two for fascia mounting. Their silver-grey powdercoating makes for a striking contrast with the aluminum of the base shoes and cap rails. The aluminum products are available with a matt silver effect or smooth mill finish. All variations are slim and elegant, contributing to a minimalistic look that provides maximum transparency.



## EASY GLASS HYBRID SPECS

- Lightweight aluminum base shoes
- Mountable with or without slender balusters
- Anchor screws will do for the installation
- With integrated water drainage system

<b>Designed for:</b>	Light to medium use
<b>Use:</b>	Indoor and outdoor
<b>Varieties:</b>	Top, fascia, or wall-to-wall mount
<b>Applications:</b>	Balustrades
<b>Material:</b>	Aluminum and powder-coated steel
<b>Infills:</b>	Glass
<b>Glass thickness:</b>	5/16" to 9/16" (8 to 13.52mm)





12

# EASY GLASS® SLIM

SLIM DESIGN, BIG IMPACT



EASY GLASS® SLIM COMBINES MODERN DESIGN,  
OPTIMAL TRANSPARENCY AND AFFORDABILITY  
IN ONE RAILING SYSTEM.

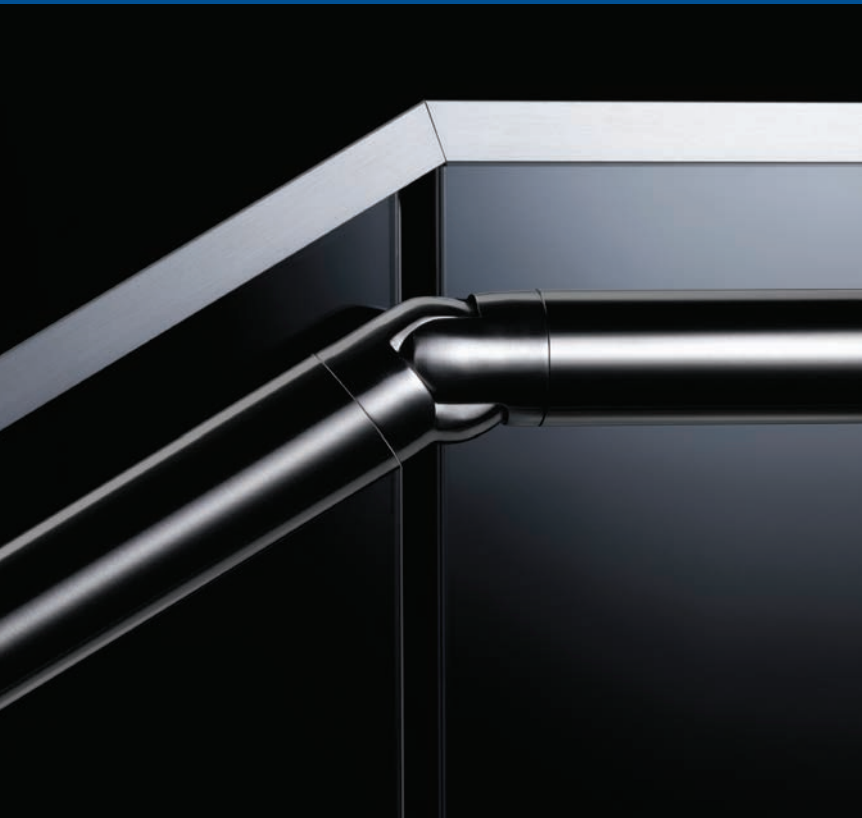

### APPROVED MINIMALISM

Easy Glass Slim meets the Miami-Dade testing standards. At only 1-3/4" (45mm) wide, the system is likely to be the slimmest approved base shoe in the industry. Its elegant shape and dimensions make it a perfect fit for today's interiors and exteriors.

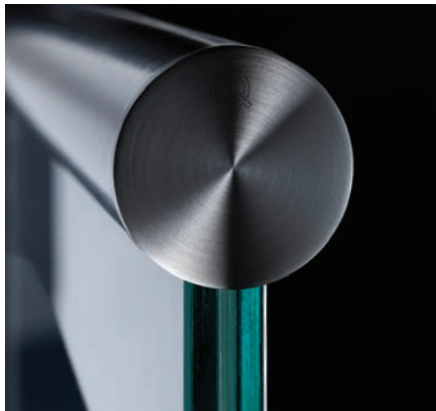





14

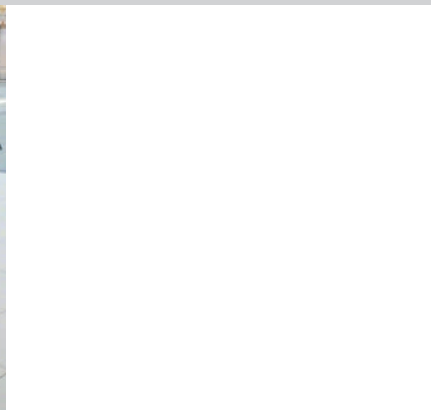

## PROJECTS

Easy Glass Slim is a complete and affordable solution both for interiors and exteriors. With its thin yet strong base shoe it is ideal for creating railings for landings, balconies and stairs in private residences, commercial buildings, shops and more.





## COST SAVING DESIGN

LOOKING TO BRING A DRAMATIC "WOW" FACTOR TO A RESIDENTIAL OR LIGHT COMMERCIAL BUILDING? TAKE A LOOK AT EASY GLASS SLIM!

This system combines a slim modern design with optimal transparency and affordability. It comes with aluminum base shoes for both top and fascia mount solutions. All are light and easy to position. Cladding is available; however, since the base shoes come with an outstanding stainless steel finish, it is not required. The Easy Glass Slim range includes corner solutions, end fittings and a wide selection of cap rails. The entire system is designed to create a perfect seamless finish.

Easy Glass Slim significantly reduces your construction costs. As with all Q-railing concepts there is no welding required to mount the base shoes – then, the glass is just easily wedged in place with Q-railing's dry-glaze Safety Wedge system.

Thoroughly tested, Easy Glass Slim holds certificates and meets the testing standards from Enforcing Authorities of over ten different countries, including the United States and Canada.

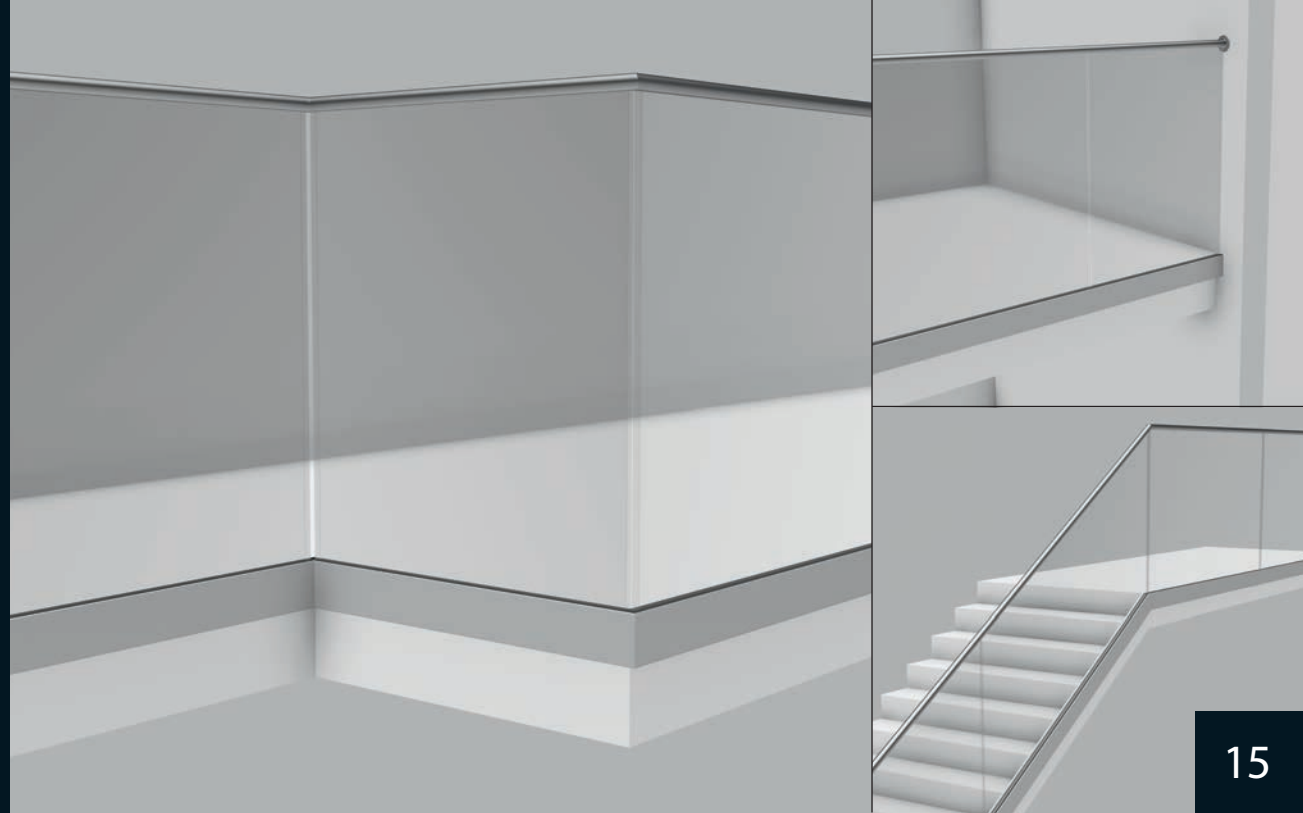

15

## EASY GLASS SLIM **SPECS**

- Slim design
- Lightweight, easy-to-manuever base shoe
- Cladding available (stainless steel or aluminum with stainless steel effect)
- Compatible with a wide range of handrails, cap rails and U-profiles in a variety of materials, shapes and sizes

<b>Designed for:</b>	Light to medium use
<b>Use:</b>	Indoor and outdoor
<b>Varieties:</b>	Top, in-floor and fascia mount
<b>Applications:</b>	Stairs and balustrades
<b>Material:</b>	Aluminum or with a smooth mill finish or stainless steel effect
<b>Infills:</b>	Glass
<b>Glass thickness:</b>	1/2" to 3/4" (12 to 19mm)





# EASY GLASS® MAX

**THE STRONGEST BASE SHOE EVER**





WHEN IT COMES TO STRENGTH AND DESIGN  
EASY GLASS® MAX IS A CHAMPION. THE  
CLEVERLY ENGINEERED SYSTEM EASILY  
WITHSTANDS HEAVY LOADS AND HIGH-WIND  
PRESSURES.



### ROBUST MINIMALISM

Designed for heavy to extremely heavy use, suitable for both indoors and outdoors, Easy Glass Max delivers maximum strength with minimum weight. Robust as it is, this glass railing system has a light and minimalistic look that allows for clear, unobstructed views.





18



## PROJECTS

Easy Glass Max's unparalleled strength makes it the perfect choice to meet the design requirements for areas with high-wind loads as well as stadiums, hospitals and other high-occupancy and emergency-type building classifications. The system was tested to requirements that are used worldwide.

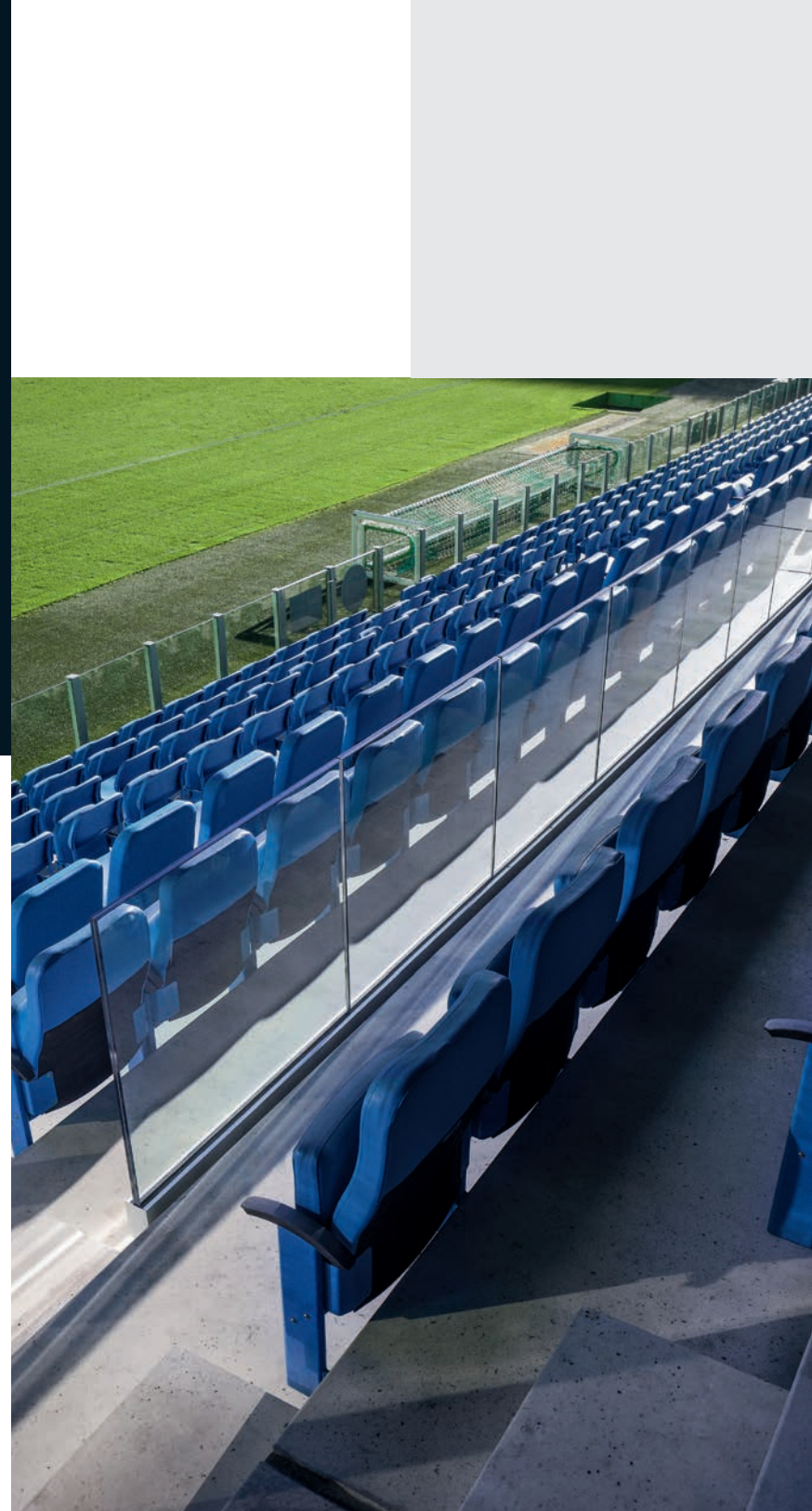



## ULTRA-STRONG

WITH FEW EXCEPTIONS EASY GLASS MAX CAN EASILY HANDLE EXTREMELY HEAVY LOADS, AS WELL AS HIGH-WIND PRESSURES.

The sense of space created by this glass railing system makes it a stunning addition to any public area. Choosing Easy Glass Max means you can select from three different base shoe types, all lightweight yet ultra-strong.

In addition to standard base shoes for regular top and fascia mounting situations Easy Glass Max includes a unique Y-shaped base shoe that is specifically designed to cover unfinished floor edges. The "Y" allows for fascia mounting the balustrade directly on the edge of concrete slabs exactly at your finished floor height.

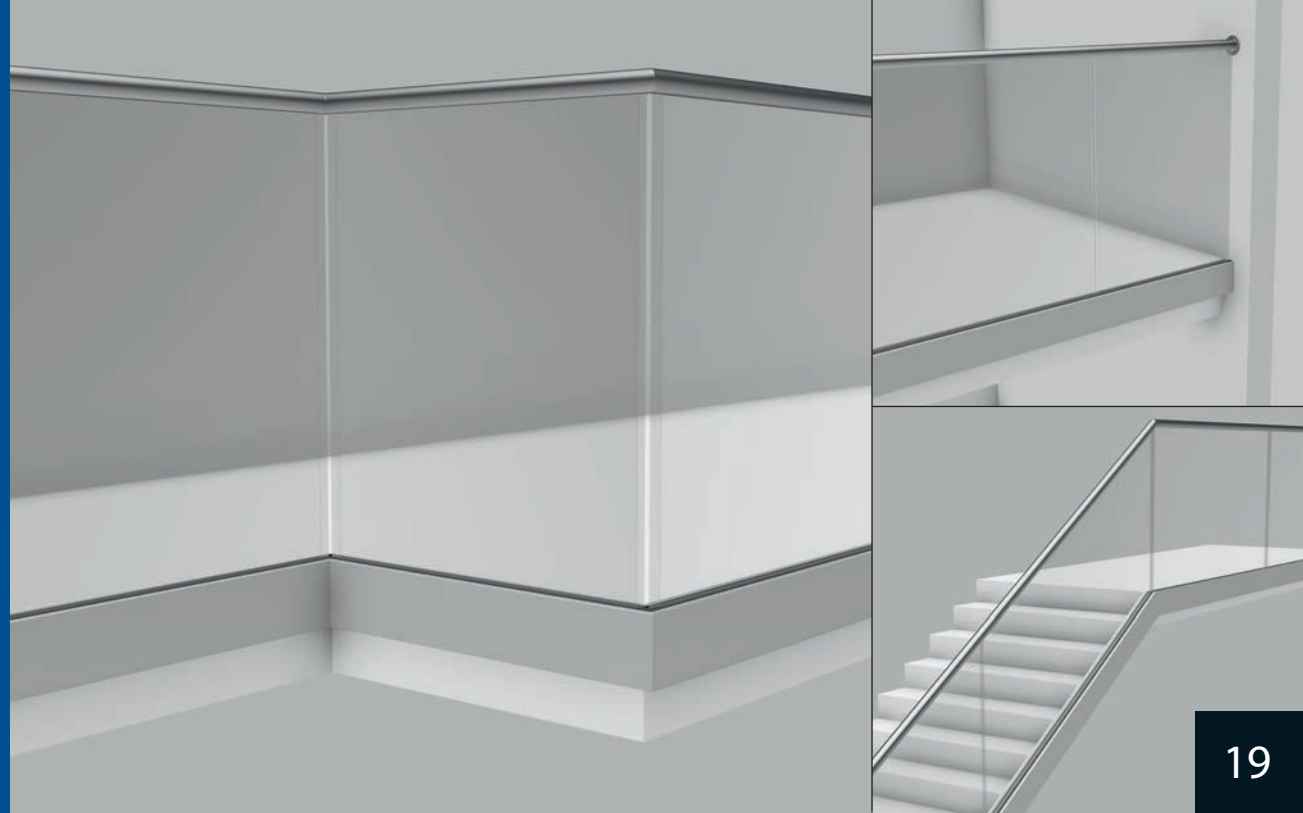

## EASY GLASS MAX **SPECS**

- Suitable for use in high demand public areas
- Easily installs on site, with no welding needed
- Comes with an integrated water drainage system
- Compatible with a vast range of handrails, cap rails and U-profiles in a variety of materials, shapes and sizes

<b>Designed for:</b>	Extremely heavy use
<b>Use:</b>	Indoor and outdoor
<b>Varieties:</b>	Top, in-floor and fascia mount
<b>Applications:</b>	Stairs and balustrades
<b>Material:</b>	Aluminum with stainless steel effect or special stainless steel effect IX
<b>Infills:</b>	Glass
<b>Glass thickness:</b>	1/2" to 1-1/4" (12 to 31.52mm)







# BALUSTER RAILING SYSTEMS



# Q-LINE

THE TIMELESS CLASSIC



WHEN YOUR PLAN CALLS FOR A RAILING SYSTEM THAT IS BASED ON ROUND SHAPES, Q-LINE PROVIDES UNLIMITED DESIGN POSSIBILITIES.



### ALWAYS IN STYLE

What makes Q-line truly classic is its timeless, minimalist design that is paired with clean and straightforward shapes in rich satin or polished stainless steel. Its contemporary looks will last for years – while its appearance will never go out of style.

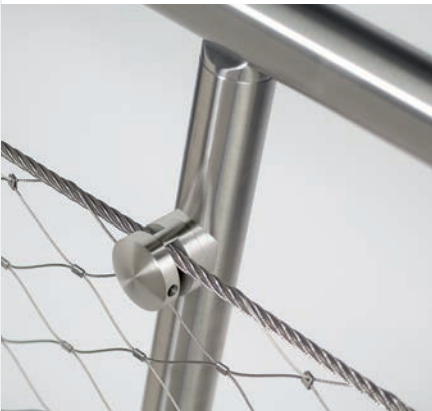



## PROJECTS

There is no system that is more complete, versatile and modular than Q-line. You can choose from numerous different products in rich satin or polished stainless steel finishes to create the exact look you have in mind. That is why Q-line can be so easily integrated into a variety of architectural settings.





## THE GREATEST SELECTION

THE Q-LINE BALUSTER RAILING SYSTEM ADAPTS TO EVEN THE MOST CHALLENGING DESIGN OR CONSTRUCTION DEMANDS.

The range includes a wide array of superior pre-fabricated high-quality components and infills. Q-line can just as easily be transformed into a transparent and efficient glass railing as it can into an industrial design element. Simply substitute glass for a stainless steel tube or bar infill to create modern and sleek horizontal, vertical or even diagonal lines. Or try something new and choose from two different cable infill systems. Each option is easy to install, durable and long lasting.

If opting for a glass infill, Q-railing's Glass Frame Tube might be the solution for you. This horizontal "tube and clamp" system for glass panels has a beautiful, seamless design. Glass Frame Tube allows you to place the glass panels outside rather than between the balusters posts. This makes it possible to use longer lengths of glass and leaves more space on balconies and stairs.

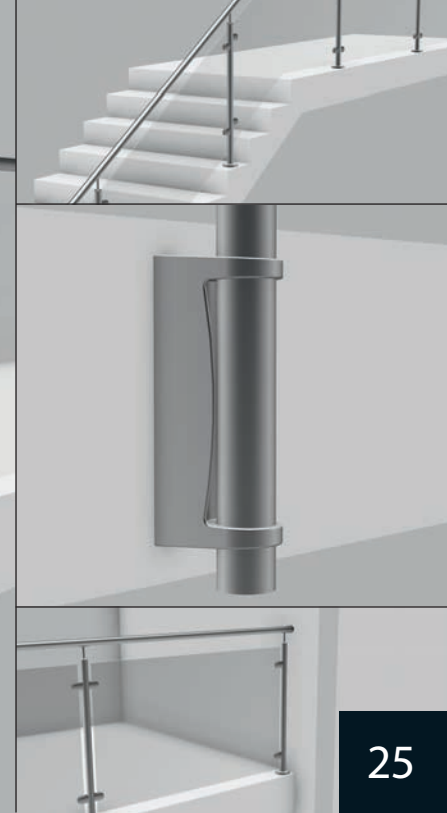

25

## Q-LINE SPECS

- No welding required – installation by specialty adhesive, drilling and tapping
- With a rich satin or polished stainless steel finish
- Compatible with a vast range of handrails in a variety of materials, shapes and sizes
- Can be combined with components from other Q-railing systems

**Designed for:** Light to medium use  
**Use:** Indoor and outdoor  
**Varieties:** Top and fascia mount  
**Applications:** Stairs and balustrades  
**Material:** 304 or 316-grade stainless steel  
**Infills:** Bars, cables, Easy Q-web or glass with glass clamps, glass spider adapters or Glass Frame Tube  
**Glass thickness:** 1/2" to 11/16" (12 to 17.52mm)





SQUARE LINE®  
STYLISH GEOMETRIC DESIGNS



MAKE A BOLD STATEMENT WITH STRONG SQUARE CORNERS, SLIGHTLY EASED EDGES AND LONG LINEAR LINES.



### PROVEN DESIGN

Square Line® is the geometric answer to the demand for the modern and edgy look of today. This baluster railing system proves how simple good design can be. Its straightforward lines and corners will transform your architectural plan with linear, modern-looking components.





## PROJECTS

From office buildings to balconies, design professionals worldwide are incorporating this minimalistic, on-trend look into their designs. Once experienced, all enjoy the intelligent engineering of these stainless steel baluster railings and applaud their fresh approach to high design.

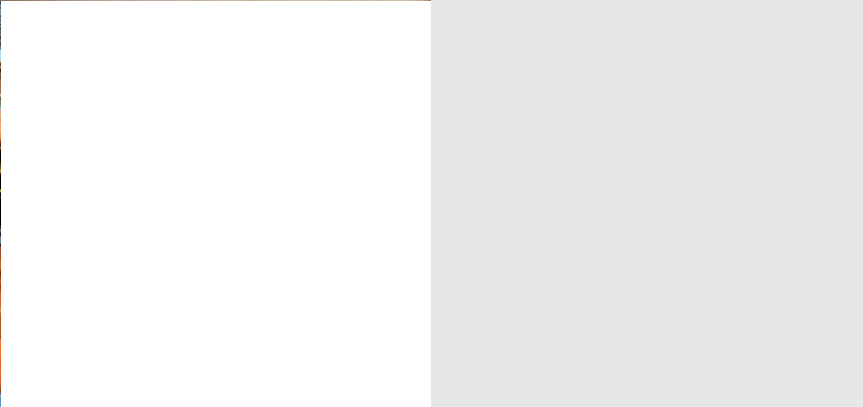



## EDGY CONCEPT

SQUARE LINE IS A MODULAR SYSTEM THAT REVOLVES AROUND SQUARE AND RECTANGULAR ELEMENTS.

Combine Square Line with other geometrically-shaped Q-railing components or opt for stark contrasts by combining this system's elements with round-shaped parts from any of the other Q-railing systems. Infill choices include bars, cables, web and glass.

Square Line gives you that 100% square look. The high-grade stainless steel components and fittings are perfectly adjusted to connect easy and seamlessly.

Create a stronger version of our popular Square Line by substituting its baluster posts for Square Line® 60x30 posts. The Square Line 60x30 system has been extensively tested and is capable of carrying heavy loads while maintaining the same minimalistic and clean design aesthetics.



## SQUARE LINE SPECS

- No welding required – installation by specialty adhesive, drilling and tapping
- Square Line 60x30 comes with 2-3/8" x 1-3/16" (60 x 30mm) uprights and 2-3/8" x 3/4" (60 x 20mm) handrail
- Compatible with a vast range of handrails in a variety of materials, shapes and sizes
- Can be combined with components from other Q-railing systems

<b>Designed for:</b>	Light to medium use
<b>Use:</b>	Indoor and outdoor
<b>Varieties:</b>	Top and fascia mount
<b>Applications:</b>	Stairs and balustrades
<b>Material:</b>	304 or 316-grade stainless steel
<b>Infills:</b>	Bars, cables, Easy Q-web or glass with glass clamps or glass spider adapters
<b>Glass thickness:</b>	1/2" to 11/16" (12 to 17.52mm)





# HANDRAIL SYSTEMS

# Q-HANDRAIL



NECESSARY FOR SAFETY, WHEN DONE WELL -  
HANDRAILS CAN ALSO BE AN INTEGRAL PART  
OF A BUILDING'S AESTHETICS.



## MATCH YOUR VISION

A great-looking handrail can transform your space. Different materials create different aesthetics. The Q-handrail range gives you a choice of handrails in stainless steel and various types of wood. Regardless of the situation, you will always find a bracket to match your vision and requirements.

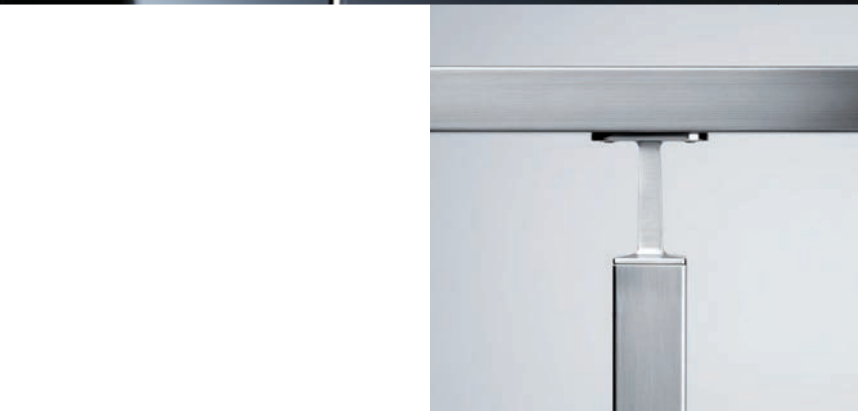





34



## PROJECTS

Nothing else is as multi-purpose as a handrail. Use it as a safety element on staircases in projects varying from private residences to large commercial builds. Or embed it on crowd control stanchions, pedestrian barriers or walls in crowded public areas such as airports, concert halls and sports stadiums.





## ENDLESS POSSIBILITIES

THE Q-HANDRAIL RANGE CONTAINS AN ENDLESS SELECTION OF HANDRAIL COMPONENTS

Let your imagination soar with the Q-handrail range. There are no limits to your design possibilities! The wide selection of brackets lets you find a solution for every possible situation. Round brackets, square brackets, brackets for walls, for baluster posts, for mounting directly on glass – all are available.

One of the Q-handrail highlights is Square Line® 40x10. This minimalist handrail system highlights straight lines and flat shapes. Choosing the correct end pieces and connectors will guarantee stunning results.

What is more, discover the unique, clean look of Q-railing's high-end brackets with blind attachments. These brackets have no visible screws to detract from the design.

Q-handrail's virtually seamless pre-engineered fittings eliminate visually distracting lines to further enhance the appearance of your railing designs. In addition, the range offers flexible fittings that easily adjust to your installation demands.



## Q-HANDRAIL SPECS

- No welding required – installation by specialty adhesive, drilling and tapping
- Pre-fabricated, pre-finished tubing available in a wide range of common lengths
- Components designed to fit together perfectly
- Flexible fittings, a wide range of end caps and wall returns, and solutions for a variety of corners
- A wooden handrail variant for outdoor use is available as well

<b>Designed for:</b>	Light to medium use
<b>Use:</b>	Indoor and outdoor
<b>Varieties:</b>	Wall, baluster and glass mount
<b>Applications:</b>	Stairs, balustrades and guards
<b>Material:</b>	304 or 316-grade stainless steel or wood (beech, oak or cedar)
<b>Diameters:</b>	1.5" (38.1mm), 1.67" (42.4mm), 1.9" (48.3mm) or 2" (50.8mm)





36

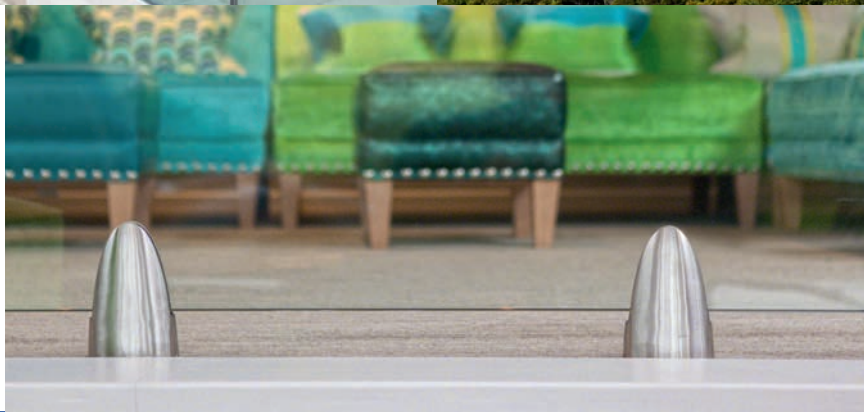
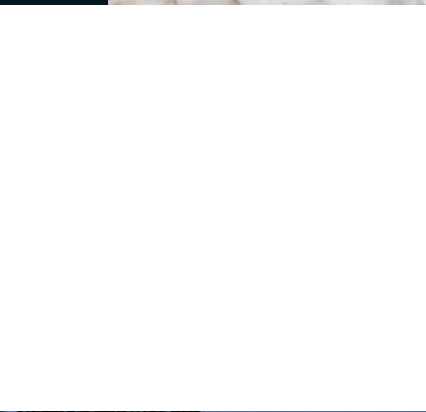



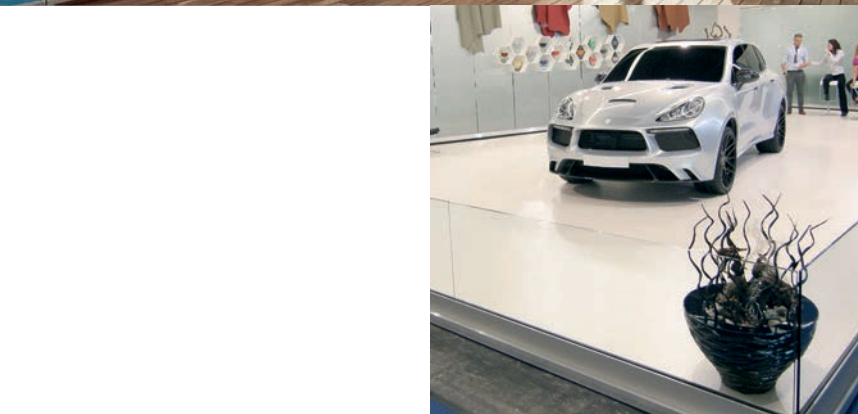



BRING YOUR VISION TO LIFE

# WWW.Q-RAILING.COM

- Downloadable CAD drawings, BIM objects and architectural specifications
- Clear overviews of all Q-railing products and systems
- Numerous inspirational references and images

